

PEDESTAL ROLLER FAIRLEAD

PFH-12

STANDARD FEATURES

- Designed for Maximum SWL of 90MT per OCIMF Recommendations
- Heavy Duty Cast Steel Construction
- Grease Lubricated Bronze Bearings
- Heat Treated Roller for Longer Life
- Weld Down Mounting Base
- Epoxy Primer Coating

OPTIONAL FEATURES

- Customized Design to Suit Your Application
- Custom Mounting Bases
- Three Coat Marine Paint System
- Third Party Certification

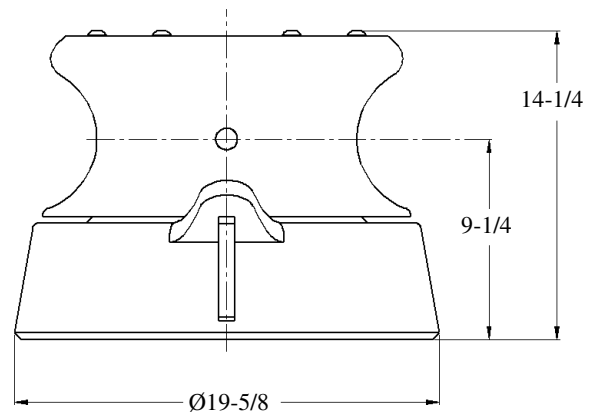
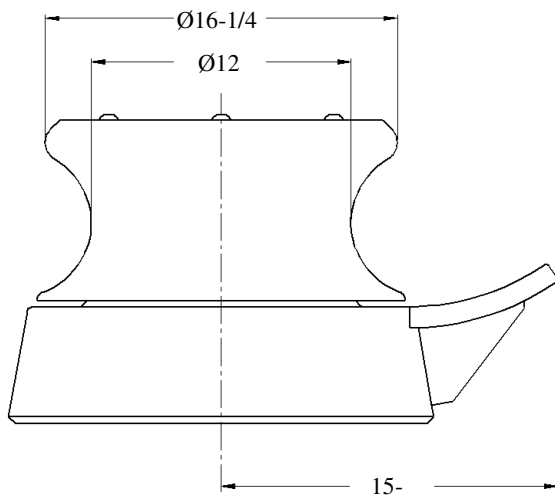

WEIGHT: 322 LBS

* DIMENSIONS SUBJECT TO CHANGE WITHOUT NOTICE*

Rasmussen Equipment Company

415 S. Cloverdale St. Seattle, WA 98108
Tel: 206-762-3700

2220 Engineers Rd Belle Chasse, LA 70037
Tel: 504-392-0442

E-mail: info@RasmussenCo.com Web: www.RasmussenCo.com Toll Free: 800-227-7920